



# **WELCOME**

## **RADIANT CONVECTOR GAS FIRE**

**Installation and Maintenance Instructions**

**Hand these instructions to the user**

**Model No's FWERN0MN & FWERR0MN are for use on Natural Gas (G20) at a supply pressure of 20 mbar in G.B. / I.E.**

# CONTENTS

## Contents

<b>Installation Instructions</b>		<b>Page</b>
Appliance Data		3
Section 1	1.1 Conditions of Installation.	4
	1.2 Flue & Chimney Suitability	4
	1.3 Fireplace/Surround Suitability	5
	1.4 Shelf Position	5
	1.5 Side Clearance	5
	1.6 Closure Plate	5
	1.7 Flue & Chimney inspection	5-6
	1.8 Chimney Catchment space	6
	1.8.1 Brick Built Chimney	6-7
	1.8.2 Fitting to Pre-Fab. Twin Wall Metal Flueboxes	7
	1.8.3 Fitting to Pre-Cast Flue Installations	8
	1.9 Hearth Fitting	8
	1.10 Wall Mounting	8
	1.11 Spillage Monitoring System	8
Section 2	2.1 Packing Check List	9
	2.2 Installation of Fire	9-10
	2.3 Gas Connection	11
	2.4 Gas Soundness	12
Section 3	3.1 Completing the Assembly	12
	3.2 Lighting the Appliance	12
	3.3 Checking for Clearance of Combustion Products	13
	3.4 Final Checks	14
	3.5 Electrical Connection	14
Section 4		
<b>Maintenance Instructions</b>		
	4.1 General Access for Servicing	15
	4.1.1 Removal of the Upper Canopy	15-16
	4.2 Removal of the Burner Assembly	16-17
	4.3 Removal of the Control Tap	18-19
	4.4 Removal of the ODS	19
	4.5 Removal / Replacement of the Radiants	19
	4.6 Removal / Replacement of the lightbulbs	19-20

## **APPLIANCE DATA**

Main injector (1 off) Pilot Type. Type	Bray Elbow size 420, Cat 82 Copreci Single Flame 21100 / 141
Max. Gross Heat Input : Min. Gross Heat Input :	6.6 kW 2.0 kW
Cold Pressure :	20.0 +/- 1.0 mbar (8.0 +/- 0.4 in w.g.)
Ignition :	Rotary piezo, integral to gas valve
Electrode Spark Gap :	4.0 mm
Weight (Packed) :	21.5 kg
Supply Voltage Fuse Rating Mains Cable Illumination	230V ac, 50Hz 3 Amp 1 x 1.8M PVC 1mm <sup>2</sup> 2 x 60W BC Fireglow Bulb

### **Firebox Dimensions (with case fitted)**

Width :	715mm
Height : (without feet fitted)	680mm
Depth :	300mm
Height to top of the flue spigot :	420mm
Gas Connection :	8mm compression (Supplied with fire)

## 1.1 CONDITIONS OF INSTALLATION

### **In Great Britain :-**

It is law that all gas appliances are installed only by a CORGI registered installer in GB, in accordance with these installation instructions and the Gas Safety (Installation and use) Regulations 1998. Failure to install appliances correctly could lead to prosecution. It is in your own interest and that of safety to comply with the law.

The installation must also be in accordance with all relevant parts of the Local and National Building regulations where appropriate, the Building Regulations (Scotland Consolidation) issued by the Scottish Development Department, and all relevant recommendations of the following British Standard Code of Practice, and in accordance with the latest IEE Wiring Regulations.

1. B.S. 5871. Part 1. Installation of Gas Fires.
2. B.S. 5440.: 2000 Parts 1 & 2. Installation of Flues & Ventilation.
3. B.S. 6891. Installation of Gas Pipework.
4. B.S. 6461. Part 1. Installation of Chimneys & Flues.
5. B.S. 1251. Open Fireplace Components.
6. B.S. 715. Metal Flue pipes for Gas Appliances.
7. B.S. 1289 Clay Flue blocks and Terminals.
8. B.S. 7566 Installation of factory-made Chimneys.

### **Ventilation Requirements**

**For use in G.B. purpose built ventilation is not normally required for this appliance.**

### **In Republic of Ireland :-**

**For use in I.E. this appliance must be installed in accordance with the rules in force by a competent person and used only in a sufficiently ventilated space. Please consult document *I.S. 813 : 1996 Domestic Gas Installation*, issued by the National Standards Authority of Ireland.**

## 1.2 FLUE AND CHIMNEY SUITABILITY

The appliance is designed for use with conventional brick built chimneys or lined chimneys and pre – fabricated flues. It is also suitable for use with pre-cast flue blocks conforming to B.S. 1289 and metal flue boxes conforming to BS 715. All flues must conform to the following minimum dimensions.

<b>Minimum diameter of circular flues</b>	<b>125 mm</b>
<b>Minimum effective height of all flue types</b>	<b>3 metres</b>
<b>Minimum cross sectional area of Pre-cast Flues</b>	<b>122.7 cm<sup>2</sup></b>

### 1.3 FIREPLACE / SURROUND SUITABILITY

The fire is suitable for hearth mounting or wall mounting. It must **not** be fitted directly onto a carpet or other combustible material. It must **not** be fitted to combustible walls.

This fire is suitable for the following hearth / surround types:

Non-combustible hearths / surrounds.

Purpose made proprietary hearths / surrounds with a minimum temperature rating of 150°C.

**If a heating appliance is fitted directly against a wall without the use of a fireplace or fire surround, soft wall coverings such as wallpaper, blown vinyl, etc. could be affected by the heat and may, therefore scorch or become discoloured. Please bear this in mind when installing or decorating.**

### 1.4 SHELF POSITION

The fire may be fitted below a combustible shelf providing there is a minimum distance of 100 mm above the top of the fire and the shelf does not project more than 150 mm. If the shelf overhangs more than 150 mm the distance between the fire and the shelf must be increased by 25 mm for every 25 mm of additional overhang over 150 mm.

### 1.5 SIDE CLEARANCE

A minimum clearance of 100mm should be allowed on either side of the fire for servicing. Any fire surround uprights should not project forward by more than 100mm.

NOTE. The fire must be installed so that no part of a combustible side wall when measured laterally is less than 500mm from the radiants.

### 1.6 CLOSURE PLATE

A closure plate is supplied with this fire and **must** be fitted. The closure plate must be sealed to the fireplace or surround opening with suitable adhesive tape. See section 2.2.2

### 1.7 FLUE / CHIMNEY INSPECTION

Before commencing installation, a flue or chimney should be inspected to ensure that all the following conditions are satisfied.

- a) Check that the chimney / flue only serves one fireplace and is clear of any obstruction. Any obstruction. Any dampers or register plates must be removed or locked in the open position.

- b) Brick / stone built chimneys and any chimney or flue which has been used for an appliance burning fuel other than gas must be thoroughly swept. The base of the chimney/flue must also be thoroughly cleared of debris etc.

Any under floor air supply to the fireplace must be completely sealed off.

Ensure that the inside of the chimney/flue is in good condition along its length and check that there is no leakage of smoke through the structure of the chimney during and after the smoke pellet test.

With pre-cast flues it is especially important to check the inside of the flue for extruded cement / sealant protruding from the joints between the flue blocks. If present, these should be removed by rodding the flue before proceeding with the installation.

Using a smoke pellet, check that there is a positive up draught present in the chimney / flue and that the smoke can be seen issuing from the terminal / chimney pot outside. There must be no leakage of smoke through the structure of the chimney during or after the smoke pellet test and it is important to check inside upstairs rooms adjacent to the chimney / flue. Check the chimney pot / terminal and general condition of the chimney brickwork or masonry. If the chimney or flue is in poor condition or if there is no up draught do not proceed with the installation. If there is a history of down draught conditions with the chimney / flue, a tested and certified flue terminal or cowl suitable for the relevant flue type should be considered.

**A spillage test must always be carried out during commissioning of the appliance.**

## **1.8 CHIMNEY CATCHMENT SPACE.**

### **1.8.1 Brick Built Chimneys.**

The catchment space below the flue spigot should be as deep as possible, and must not be less than 250mm measured from the bottom of the flue spigot to the bottom of the catchment space, or to the top of any “bricking-up” of the fireplace, whichever is the least. See Fig. 1.

The flue spigot must pass through the closure plate at least 25mm and have a minimum clearance of 50mm between its open end and the nearest obstruction. There must be a minimum clearance of 165mm between the back of the closure plate and the back of the catchment space. See Fig. 1 overpage.

The front opening of the fireplace must be between 305mm and 440mm wide, and between 470mm and 650mm high. If the opening is larger than this, then a surround must be constructed in a suitable non-combustible material to create an opening to these limits. Allow a minimum flat surface of 20mm around the opening to ensure that the closure plate can be sealed to the fireplace.

Any surround must be sealed to the fireplace to prevent leakage. The operation of the chimney should be tested as detailed as in section 1.7.

Note. A flue spigot extension of up to a maximum total length of 125mm may be fitted if necessary, providing that a minimum clearance of 50mm between its open end and nearest obstruction is always maintained.

**Fig.1. Chimney Catchment Space.**

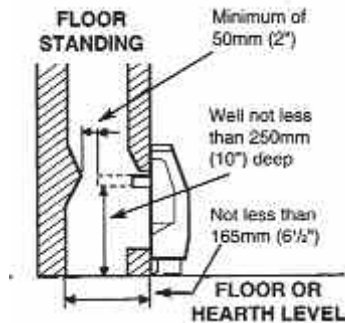

### 1.8.2 Fitting to Pre-Fabricated twin wall metal Flue Boxes.

The appliance may be fitted to a twin wall metal flue box conforming to the constructional requirements of BS 715, (for example the Selkirk LFE 125 box). The box must have a minimum flue diameter of 125mm internal and minimum internal dimensions of 160mm deep by 580mm high by 350mm wide. There are no maximum dimensional requirements for the box. The top face of the box must be insulated with a minimum thickness of 50mm of non-combustible mineral wool insulation or similar material. The flue box must stand on a non-combustible base of minimum thickness 12mm.

### 1.8.3 Fitting to Pre-Cast Flue Installations.

The pre-cast opening must be a minimum of 122.7cm<sup>2</sup> or equivalent cross-sectional area and have a minimum effective flue height of 3 metres. The flue spigot restrictor must be removed when installing into pre-cast flue applications. **This appliance has been tested for use in a pre-cast flue block complying with BS 1289. In accordance with BS 1289 Part 1, pre-cast flues built with directly plastered faces (front or rear) are not correctly installed as to ensure proper operation with any type of gas fire. In some instances of this flue construction, temperature cracking of surface plaster may occur through no fault of the appliance. An air gap or some form of insulation material should be installed to prevent normal flue temperatures from damaging wall surfaces.**

## 1.9 HEARTH FITTING

This appliance must only be installed on to a level concrete or non-combustible hearth. The feet must not be removed when installing directly onto a hearth. The hearth material must be a minimum thickness of 13 mm with the top surface at least 50 mm above the floor level. The hearth **must** be fitted symmetrically about the fire opening and have a minimum width of 760 mm and a minimum projection of 300 mm forwards from the fire opening.

## 1.10 WALL MOUNTING

The fire can be fitted to non-combustible walls. The top of the fire place opening being at least 550mm above the floor level. The wall should be plugged and the fire secured to the wall with suitable screws. See "Wall Mounting" in the installation section.

## 1.11 SPILLAGE MONITORING SYSTEM

This appliance is fitted with an atmosphere sensing spillage monitoring system in the form of an oxygen sensing pilot. This is designed to shut the fire off in the event of partial or complete blockage of the flue causing a build up of combustion products in the room in which the fire is operating. **The following are important warnings relating to the spillage monitoring system:**

The spillage monitoring system must not be adjusted by the Installer. The spillage monitoring system must not be put out of action. When the spillage monitoring system is exchanged, only a complete original Manufacturers part may be fitted. It is not possible to replace individual parts on the pilot system on the appliance, only a complete pilot assembly (including thermocouple) may be fitted.



## 2.1 PACKING CHECK LIST

- 1 off Firebox / Burner Assembly
- 1 off Flue Spigot
- 1 off Closure Plate
- 1 off Literature / Loose Items Pack
- 4 off Ceramic Radiants – Packed inside top fitting

## 2.2 INSTALLATION OF FIRE

### 2.2.1 Preparation.

- a) Remove the dress guard by springing the location wires out at the top and lifting away. See Fig. 2. **Take care not to scratch the trim.**

**Fig. 2 Remove the Dress Guard.**



- b) Remove the flue spigot restrictor if the fire is to be fitted to a pre cast flue. The flue spigot restrictor is attached to the spigot with two screws.
- c) Fit the flue spigot to the back panel using four screws provided.

## Closure plate.

- a) Fit the closure plate to the fireplace opening and ensure that it has a flat sealing area of at least 10mm sealed on all sides. See Fig. 3 below  
Dimensions stated are for closure plate supplied

**Fig. 3**

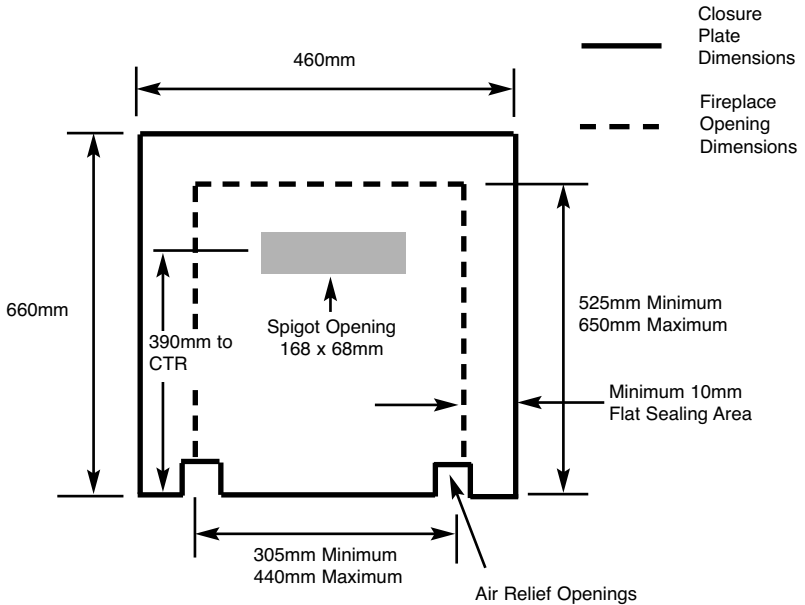

Check the operation of the chimney as follows:-

Apply a smoke match to the flue spigot opening in the closure plate and observe the smoke. If there is a definite flow into the opening then proceed with the installation. If there is not a definite flow into the opening, pre-heat the chimney for about two minutes and retest for flow. If there still is no definite flow into the opening, the chimney may require attention. **DO NOT FIT THE FIRE-SEEK EXPERT ADVICE.**

## 2.3 GAS CONNECTION

**Note :** A means of isolation must be provided near to the appliance to facilitate servicing.

Ensure that the gas supply is turned off before commencing.

The gas connection should be made to the appliance inlet elbow using 8 mm rigid tubing. The gas connection can be made left hand, right hand or rear. In line with current installation regulations, a restrictor should be fitted to the inlet pipework to isolate the appliance for servicing and repair purposes.

**Before making the final gas connection, thoroughly purge the gas supply pipe work to remove all foreign matter, otherwise serious damage may be caused to the gas control valve on the fire.**

## **2.4 GAS TIGHTNESS**

- a) Remove the pressure test point screw from the inlet elbow and fit a manometer.
- b) Turn on the main gas supply and light the fire as described in section 3.2 and carry out a gas tightness test.
- c) Check that the gas pressure is 20.0 mbar ( $\pm 1.0$  mbar), 8.0 in w.g.  $\pm 0.4$  in w.g.
- d) Turn off the fire, remove the manometer and refit the pressure test point screw. Check the pressure test point screw for gas tightness with the appliance turned on using a suitable leak detection fluid or detector.

## **3.1 Completing the Assembly**

- a) Fit the radiants by carefully inserting the upper end first into the radiant canopy, and then lowering and seating the base of the radiants into the radiant support channel.
- b) Refit the dress guard.

## **3.2 Lighting the Appliance**

- a) Light the pilot by depressing the control knob at the "off" position and turn anti-clockwise (with the control depressed) to the second position marked \*.
- b) When the pilot lights, (pilot can be seen through the bottom window of right hand radiant) hold the control knob down for 10 seconds.
- c) If the pilot fails to light, repeat the ignition sequence and hold in the control knob for slightly longer.
- d) When the pilot has lit, release the control knob from the depress position, depress slightly again and turn the control anti-clockwise to the high position and check for clearance of combustion products as detailed below.

### 3.3 Checking for Clearance of Combustion Products

- a) Close all doors and windows in the room. Remove the dress guard.
- b) Light the fire and turn to the maximum position.  
After 5 minutes hold the smoke match as shown in Fig. 4. Whilst holding the smoke match in the correct position, approximately 5mm below and inside the lower edge of the centre of the canopy. Ensure that most of the smoke is drawn into the flue aperture. If in doubt repeat the exercise after a further 5/10 minutes.

**Note:-** It is recommended that the smoke match is fitted into an approved smoke match holder, when checking for clearance of combustion products.

**Fig. 4**

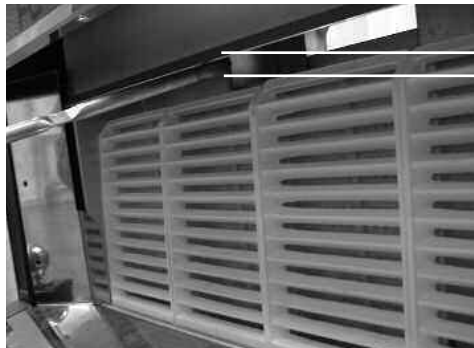

Smoke match position approx. 5mm below and inside the front edge of the combustion chamber lid.

- e) If the smoke is not drawn into the flue aperture, remove the flue spigot restrictor if fitted and repeat the spillage test.

If there is an extractor fan fitted in a joining room, then the spillage test must be repeated with the fan switched on and running at maximum speed. All interconnecting doors must be opened in accordance with the latest issue of BS 5440.

## IF SPILLAGE IS DETECTED

The cause must be discovered and the fault corrected. If the fault cannot be corrected disconnect the appliance from the gas supply and seek expert advice. Possible causes of spillage from the appliance are:- chimney restriction, down draught or insufficient air supply to the room.

- g) After ensuring that the fire is safe to use it should be left on “High” position to fully warm up. During this time a slight odour may be noticed, this is due to the “newness” of the fire and will soon disappear.

### 3.4 Final Check

- a) Refit the Dress-guard if it has not already been re-fitted.
- b) Recheck the operation of the fire on all settings.
- c) Make sure that the User knows how to operate the fire and refer them to the User Book.
- d) Inform the User that the Model Number for ordering parts is shown on the Rating plate. The rating plate can be viewed at the bottom left hand side of the rear panel.
- e) Inform the User the fire should be serviced annually for continued safe operation.
- f) Hand this instruction booklet to the customer.

### 3.5 Electrical Connection

The Flavel Welcome heater is supplied with a moulded three-pin plug (3 Amp) and approximately 1.8 metres of flexible mains cable (1mm<sup>2</sup>). The appliance and surround should therefore be located close to a suitable mains socket to enable connection. The electrical socket MUST be easily accessible to allow disconnection.

This heater MUST be earthed. If in any doubt consult a suitable competent person.

Connections

L = Brown      N = Blue    E = Green / Yellow

Replacement fuses should be approved and conform to BS 1362.

## MAINTENANCE INSTRUCTIONS

### Servicing Notes

Servicing should be carried out annually by a competent person such as a Corgi registered engineer. The service should include visually checking the chimney and fire opening for accumulations of debris and a smoke test to check for positive up-draught in the chimney. The condition of the ceramic plaques should be checked and if necessary the whole set should be replaced with a genuine replacement set. After any servicing work a gas tightness check must always be carried out.

Ensure before any servicing work is commenced that the appliance is isolated from the electrical supply.

#### 4.1 GENERAL ACCESS FOR SERVICING

##### 4.1.1 TO REMOVE THE UPPER CANOPY

- a) Prepare work area (lay down dustsheets etc.), Disconnect the appliance from the gas supply.
- b) Remove the four canopy rear fixing screws, and the two fixing screws that are located on the underside of the canopy (see fig 5 & 6 respectively)
- c) Remove the radiants and move to a safe place
- d) Re-assemble in the reverse order.

**Fig. 5 Removing the four canopy rear fixing screws**

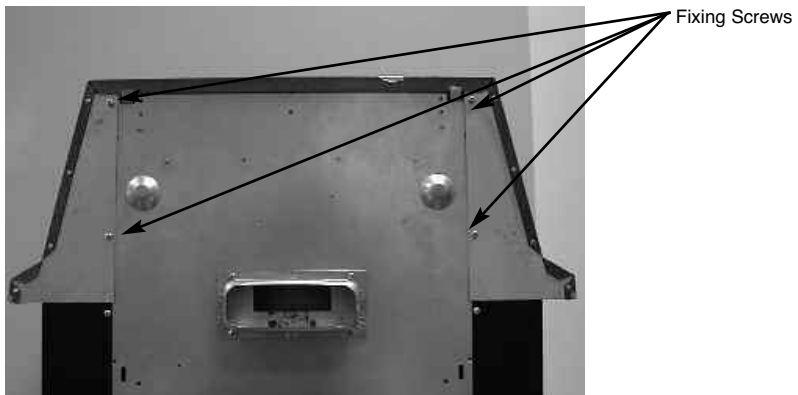

**Fig. 6 Removing the Upper Outer Case Fixing Screws**



#### **4.2 REMOVING THE BURNER ASSEMBLY FROM THE FIRE**

- a) Disconnect the appliance from the gas supply.

**Fig. 7**



- b) Remove the coal form from the front of the appliance, as shown above in Fig. 7
- c) Remove the front bezel by unscrewing the 2 retaining screws, as shown in Fig. 8 overpage.



**Fig. 8**

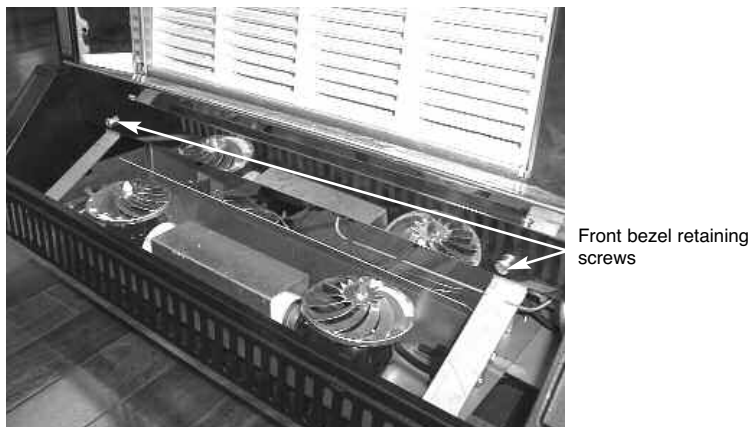

- d) Remove the four burner retaining screws, as shown below in fig. 9. Disconnect the pilot assy. and slide the burner carrier to the right and lift clear.

**Fig. 9**



### 4.3 REMOVING THE GAS VALVE FROM THE FIRE

- a) Disconnect the appliance from the gas supply.
- b) Remove the upper canopy as shown in section 4.1
- c) Remove the left hand side panel, by unscrewing the rear panel fixing screws, then the base panel retaining screw, as shown below in fig. 10

**Fig. 10**

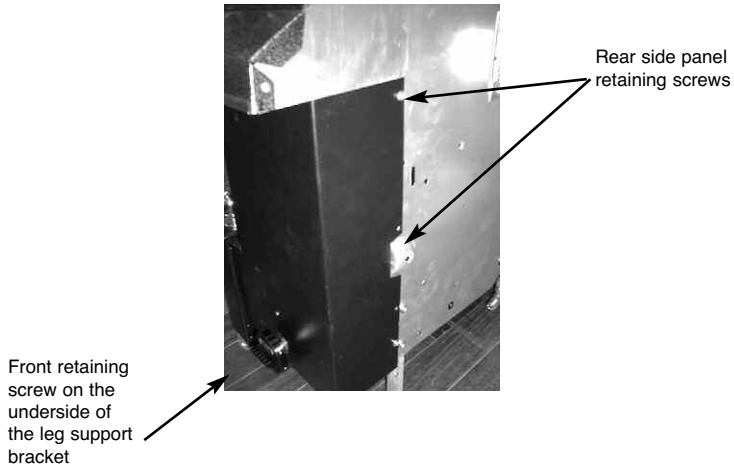

- c) Disconnect the pipes to the control valve and the control valve locknut as shown below in Fig. 11

**Fig.11**

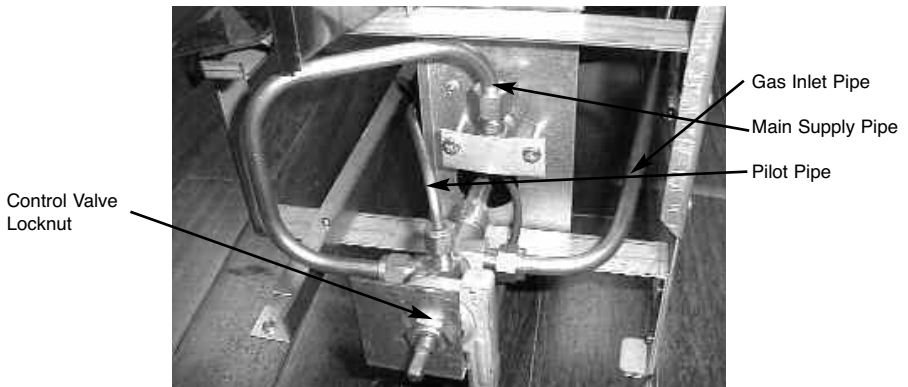

- d) Remove the thermocouple, which is a push fit into the rear of the control valve.

#### 4.4 REMOVING THE ODS- PILOT ASSEMBLY

**Note :** Because this appliance is fitted with an atmosphere sensing ODS-pilot it is not possible to replace the thermocouple separately, because the thermocouple position is factory set to a tight tolerance. Any replacement of parts on the pilot requires a complete new pilot assembly.

- a) Remove the front panel and front bezel as described in section 4.2
- b) Unscrew the pilot fixing screws. These can be accessed from the front of the appliance with the front panel and bezel removed.
- c) Remove the thermocouple as described in section 4.3. (d)

#### 4.5 REMOVAL / REPLACEMENT OF THE RADIANTS

Remove the radiants by lifting them slightly then pulling forward as shown in Fig. 12 below.

**Fig. 12**



## 4.6 REMOVAL / REPLACEMENT OF THE LIGHTBULBS

- a) **Isolate the appliance from the electricity supply.**
- b) Remove the coal form as shown on page 16, Fig 7.
- c) Remove the bulbs from the bayonet fitting and replace with a new one of the correct specification, as shown below in Fig. 13

**Fig. 13**

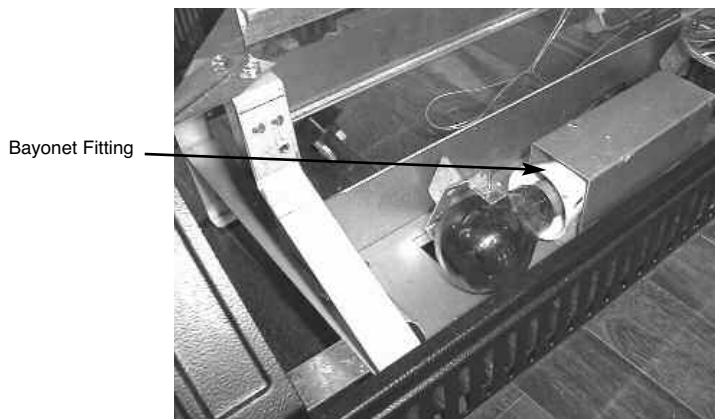

## PARTS SHORTLIST

Replacement of any other parts must be carried out by a competent person such as a CORGI registered gas installer or competent electrician.

The part numbers of the user replaceable parts are as follows, these are available from specialist spares stockists whose details can be found on our web site, [www.cfm-europe.com](http://www.cfm-europe.com), in the 'stockist' section.

Ceramic Plaques Set	FC-P079648
Gas valve	B-63250
ODS Pilot Assy. (NG)	B-48360
Control Knob	B-63520
Injector	B-63240
Mains Cable	B-77270

**Due to our policy of continual improvement and development the exact accuracy of illustrations and descriptions contained in this book cannot be guaranteed.**



# WELCOME

## RADIANT CONVECTOR GAS FIRE

### User Instructions

This section of the instructions should be read by the user before operating the appliance and retained for future reference

Model No's FWERN0MN & FWERR0MN are for use on Natural Gas (G20) at a supply pressure of 20 mbar in G.B. / I.E.

## INSTALLATION INFORMATION

### CONDITIONS OF INSTALLATION

It is the law that all gas appliances are installed only by a competent (e.g. CORGI Registered) Installer, in G.B. in accordance with the installation instructions and the Gas Safety (Installation and Use) Regulations 1998. Failure to install appliances correctly could lead to prosecution. It is in your own interest and that of safety to comply with the law.

The fire may be fitted below a combustible shelf provided that the shelf is at least 200mm above the top of the appliance and the depth of the shelf does not exceed 150mm.

The fire may be installed below combustible shelves which exceed 150mm deep providing that the clearance above the fire is increased by 15mm for each 25mm of additional overhang in excess of 150mm.

**No purpose made additional ventilation is normally required for this appliance when installed in G.B. When installed I.E. please consult document I.S. 813 : 1996 Domestic Gas Installation which is issued by the National Standards Authority of Ireland. Any purpose made ventilation should be checked periodically to ensure that it is free from obstruction.**

If the chimney or flue has been previously used by appliances burning fuels other than gas they must be swept prior to the installation of this fire.

If this appliance is fitted directly on to a wall without the use of a fireplace or surround, soft wall coverings such as wallpaper, blown vinyl etc. could be affected by the heat and hot air and may discolour or scorch. This should be considered when installing or decorating.

The appliance **MUST** be disconnected from the mains supply before commencing cleaning, or maintenance.

The Model number of this appliance is as stated on the rating plate affixed to the inner rear panel of the fire and the appliance is manufactured by:-

BFM Europe Ltd  
Trentham Lakes  
Stoke on Trent  
ST4 4TJ

## ABOUT YOUR NEW FLAVEL WELCOME GAS FIRE

The Flavel Welcome gas fire incorporates a unique and highly developed heat exchanger which combined with the radiant plaques gives maximum heat whilst maintaining reasonable running costs

Please take the time to fully read these instructions as you will then be able to obtain the most effective and safe operation of your fire.

## IMPORTANT SAFETY INFORMATION

### WARNING

**This appliance has a naked flame and as with all heating appliances a fireguard should be used for the protection of children, the elderly and infirm. Fireguards should conform to B.S. 8423 : 2002 should be fitted. (Fireguards for use with gas heating appliances).**

It is important that this appliance is serviced at least once a year by a CORGI registered gas installer and that during the service the fire is removed from the fire opening and the chimney or flue visually checked for fallen debris or blockages which must be removed. The chimney should also be checked to ensure clearance of flue products. We recommend that during the annual service, replacement of the Oxypilot is carried out. **After installation or during servicing a spillage test must always be carried out.**

Rubbish of any type must NEVER be thrown onto the ceramics, this could affect safe operation and damage the fire.

Any debris or deposits should be removed from the fuel-bed from time to time. This may be carried out by referring to the cleaning section as described later in this book.

Only the type of ceramics must be used and only complete and genuine replacement sets must be sourced from BFM Europe Ltd.

Always keep furniture and combustible materials well clear of the fire and never dry clothing or items either on or near to the fire. Never use aerosols or flammable cleaning products near to the fire when it is in use.

**The ceramic fuel-bed remains hot for a considerable period after use and sufficient time should be allowed for the fire to cool before cleaning etc. The fire must only be operated with the dress guard supplied with the fire**

## OPERATING THE FIRE

- a) Light the pilot by depressing the control knob at the “off” position and turn anti-clockwise (with the control depressed) to the second position marked \*.
- b) When the pilot lights, (pilot can be seen through the central ceramic plaque) hold the control knob down for 10 seconds.
- c) If the pilot fails to light, repeat the ignition sequence and hold in the control knob for slightly longer.
- d) When the pilot has lit, release the control knob from the depress position, depress slightly again and turn the control anti-clockwise to the HIGH position and check for clearance of combustion products as detailed below.

To utilise the electric flame effect, push the plug into a suitable mains socket outlet and switch on. When not required the appliance should be switched off at the mains outlet.

### WARNING

**If the fire goes out for any reason or is turned off and it is necessary to relight the fire it is important to allow the fire to cool for 3 minutes before attempting to re-light it.**

### SPILLAGE MONITORING SYSTEM

This appliance is fitted with a spillage monitoring system which shuts down the fire if the evacuation of combustion products from the fire is affected by a partially or fully blocked flue.

If this system operates the fire will go out. If this occurs, leave the fire for at least three minutes then follow the lighting procedure as described in the previous section. **In the event of repeated operation a CORGI registered gas installer must be called to investigate and rectify the cause.**

### CLEANING - WARNING

Before attempting any cleaning operation ensure that the fire has been allowed to fully cool.

### CLEANING THE CERAMICS

We do not recommend regular cleaning of the ceramics as these are fragile and damage may result. They may be cleaned occasionally however as described on page 6 of this user book. **None of these parts must be washed or exposed to any cleaning agents or water.**

Any damaged parts must be replaced by contacting your dealer or telephoning BFM Europe Ltd. on the number stated on the rear cover of this book. The ceramics must only be replaced with a complete and genuine replacement set and



the fire must never be run with the wrong number or damaged ceramics. The ceramics must be carefully re-assembled as stated in the following section.

## **LIGHTING WITH A SPILL**

### **Important do not light with a wax taper**

In the unlikely event of the piezo ignition unit failing to light the fire, turn the control knob to the OFF position, and wait a minute or so for the gas to disperse. The fire can then be lit by using a spill.

- a) Apply a lighted spill through bottom window of the central radiants. Light the pilot by depressing the control knob at the "off" position and turn anti-clockwise (with the control depressed) to the second position marked \*.
- b) When the pilot lights, remove the spill and continue to hold the control knob down for 10 seconds.
- c) If the pilot fails to light, repeat the ignition sequence and hold in the control knob for slightly longer.
- d) When the pilot has lit, release the control knob from the depressed position, depress slightly again and turn the control anti-clockwise to the high position.

**WARNING : Before attempting any cleaning operation ensure that the fire has been allowed to fully cool.**

## **CLEANING THE DRESSGUARD OR REFLECTOR.**

Remove the dress-guard by pulling the location wire out at the left hand side, and lifting away. See fig. 2 overpage.

Clean the dress-guard or reflector by wiping with a damp cloth, and polish with a dry duster. **DO NOT USE ABRASIVE CLEANERS**

## **CLEANING THE CASE.**

Dusting is normally all that is required. But where extra cleaning is necessary, use a damp cloth.

**Fig. 2**



### **CLEANING THE RADIANTS**

The ceramics may discolour slightly over a period of time, this is normal for radiant fires. Any dust or small soot deposits that accumulate on the ceramics can easily be cleaned. Carefully remove the ceramics and brush gently with a soft brush. To remove the ceramic, remove the dress-guard as shown in fig. 2. Remove the radiants by lifting them slightly then pulling forward as shown below in Fig. 3

**Fig. 3**



Rear face of radiant  
plaques to be placed  
against positioning  
brackets when  
re-fitting

### **REPLACING THE RADIANTS**

When replacing the radiants, always ensure that they are correctly located as shown in Fig. 3 above, with the rear face of the radiant plaque



sitting against the support bracket as shown.

## REMOVAL / REPLACEMENT OF THE LIGHTBULBS

- a) **Isolate the appliance from the electricity supply.**
- b) Remove the coal form as shown on page 16, Fig 7 of the Installation Instructions.
- c) Remove the bulbs from the bayonet fitting and replace with a new one of the correct specification, as shown below in Fig. 4

**Fig. 4**

Bayonet Fitting

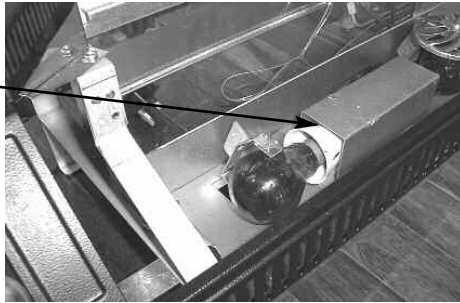

**Due to our policy of continual improvement and development the exact accuracy of descriptions and illustrations cannot be guaranteed.**

Part no. B-77280  
Issue 3



BFM Europe Ltd  
Trentham Lakes  
Stoke-on-Trent  
Staffordshire  
ST4 4TJ

**Telephone - General Enquiries :**  
**Telephone - Service :**

**(01782) 339000**  
**(0844) 7700169**